

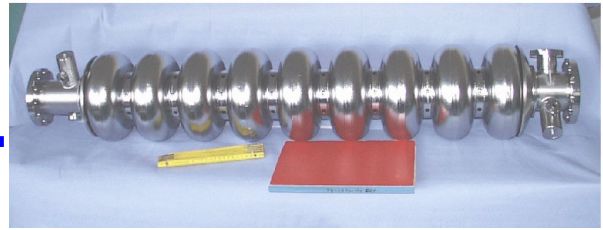

SRF



**Research and Development on Superconducting Radio-Frequency
Technology for Electron Linear Accelerators**

Deliverable 5.2.1.3.5

EP Process Parameters on Multi-Cell Cavities Fixed

A. Matheisen, N. Steinhau-Kühl, B. Meyer

Abstract

Since 2003 the DESY EP test set up is running. After a period of improvements and reconstruction the parameters for the two major EP preparation runs are fixed.

Acknowledgements

We acknowledge the support of the European Community-Research Infrastructure Activity under the FP6 “Structuring the European Research Area” programme (CARE, contract number RII3-CT-2003-506395)

Process parameters

This fixation of parameters was done according to a stable run condition of the apparatus. Since the cavity performance is subject to more parameters than the EP itself, this part of the preparation process was brought to a stable main infrastructure operation in order to be able to investigate the cavity results in respect in stable conditions in all preparation steps.

The stable operation of the EP facility (Fig. 1; 2; 3) is defined as:

- Stable conditions at the Ultra Pure (UP) Water line quality defined by TOC (Table 3); resistance of the UP water, particle contamination and particle monitoring during the assembly process. (Fig. 4; 5 ;6)
- Stable condition on secondary EP infrastructure. The stable operation is defined by the stabilization of the gas scrubber systems which was one of the major impact parameters that lead to a shut down of the EP during the running process as well.
- For the EP set up the heat exchanger setting was chosen in a way, that the current over the processing time stays constant (Fig. 4).
- Stable acid conditions

On a so called U/I measurement cell parameters like aging of acid and influence of HF concentration were studied. (Ref 1) It was found that these measurements are very sensitive to temperature changes and changes of the HF concentration of the EP acid mixture. Based on these experiments an online U/I cell was designed and installed into the apparatus (Fig. 9). A software program is designed and integrated into the PLC (Fig. 7) control system of the EP facility as well. For reproducible results, which are not influenced by a temperature change during the EP run, the PLC starts the U/I cell automatically at defined temperatures and delivers a set of data online to the operator's panel and in parallel to the data storage files of every EP run. (Fig. 8)

For the DESY EP three different temperatures are chosen to cover a wide range of the standard operation temperature range.

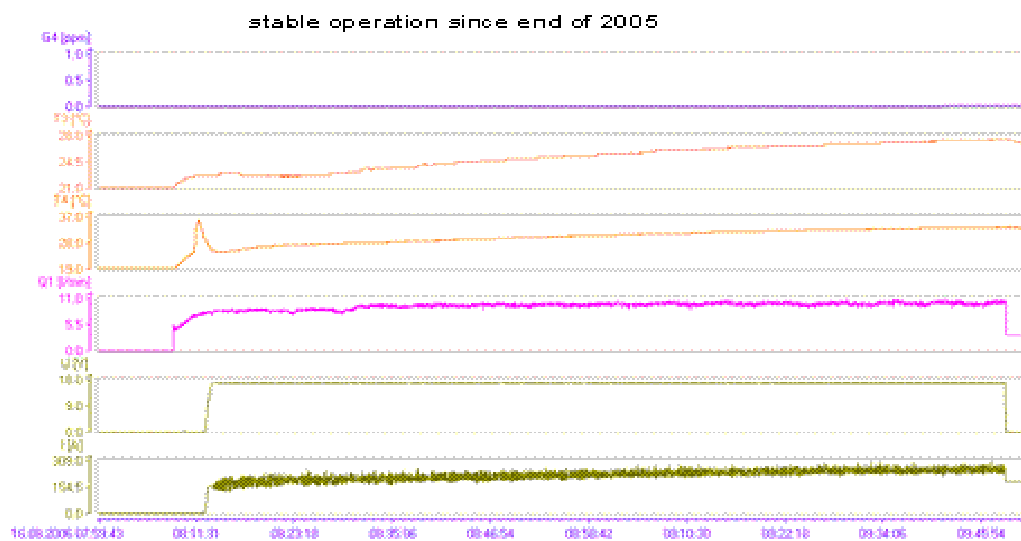

Fig. 1: example parameter set for stable operation of the EP facility
X axis: Date and Operation [HH:MM] time; **Y Axis:** G4 = HF concentration [ppm],
 T3=acid temperature cavity inlet [C], T4= Acid temperature cavity outlet [C],
 Q1= acid flow rate [l/min], U= process voltage [V], I= process current [A].

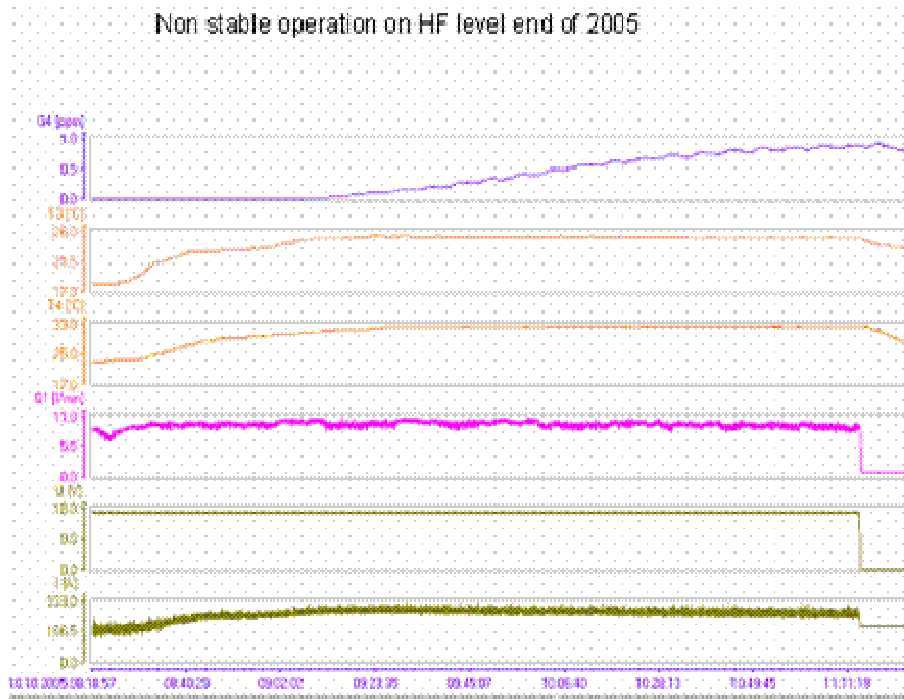

Fig. 2: example for non stable operation due to HF load of the infrastructure
X axis: Date and Operation [HH:MM] time; **Y Axis:** G4 = HF concentration [ppm],
 T3=acid temperature cavity inlet [C], T4= Acid temperature cavity outlet[C],
 Q1= acid flow rate [l/min], U= process voltage [V], I= process current [A].

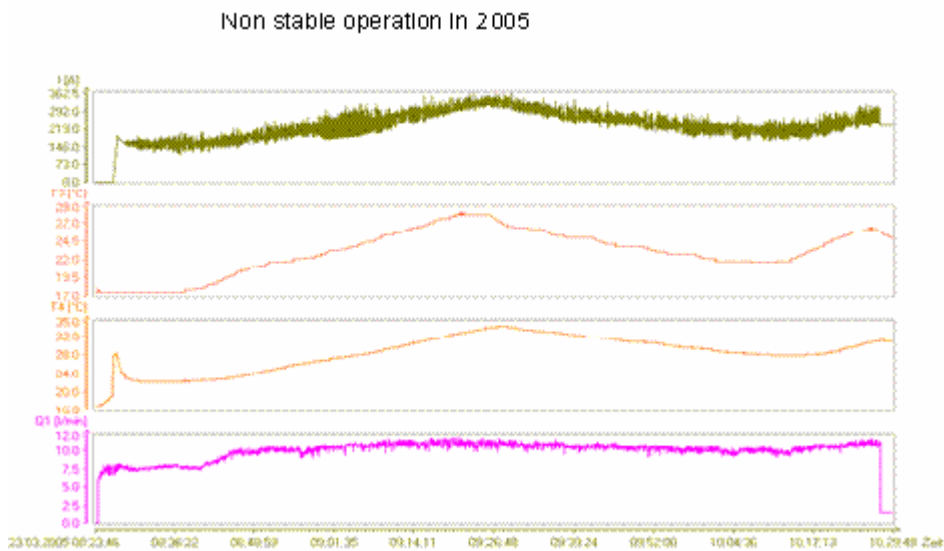

Fig. 3: Example on non stable operation due to problems on the heat exchanger
X axis: Date and Operation [HH:MM] time; **Y Axis:** T3=acid temperature cavity inlet [C],
 T4= Acid temperature cavity outlet[C], Q1= acid flow rate [l/min], I= process current [A]

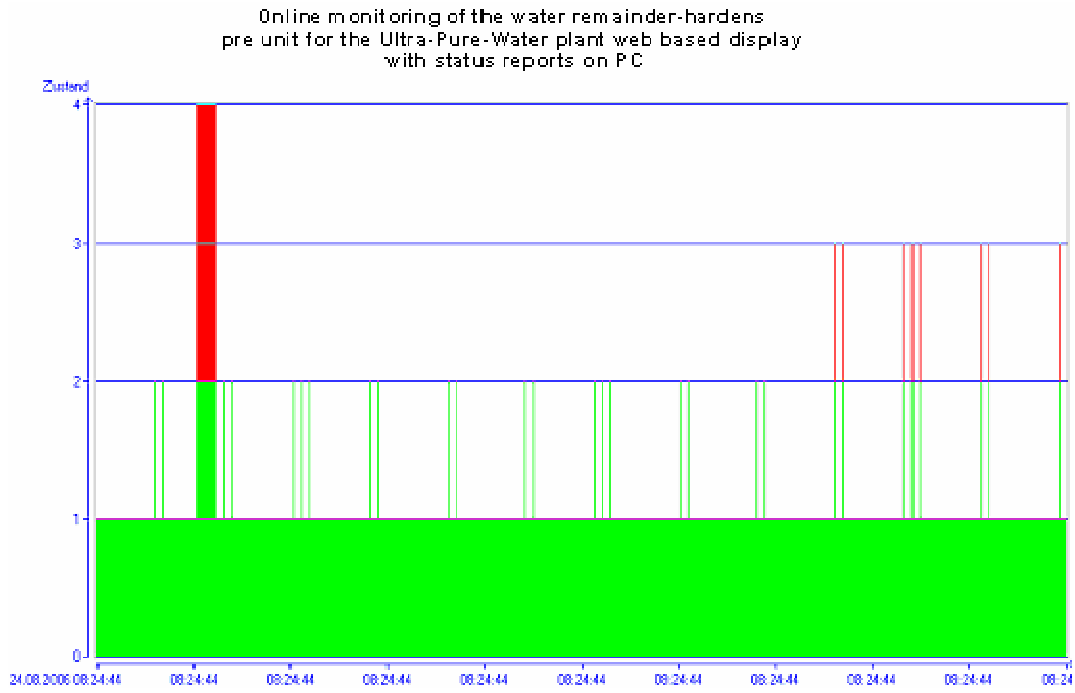

Fig. 4: example for online monitoring of the remainder –hardness control
X axis: Date and time of measurement [hh:mm:ss]; **Y Axis:** Status indication 1= operational,
 2= quality OK, 3= water quality not OK, 4= Indicator liquid for measurement missing

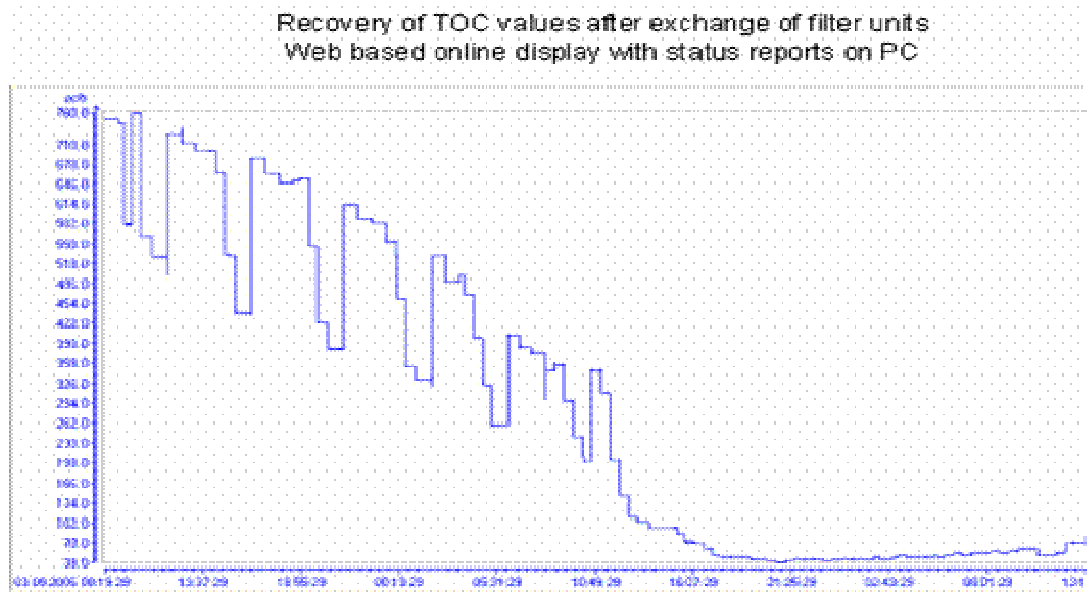

Fig. 5: example for online monitoring of the TOC control unit
X axis: Date and time of measurement [hh:mm:ss]; **Y Axis:** TOC value [ppb]

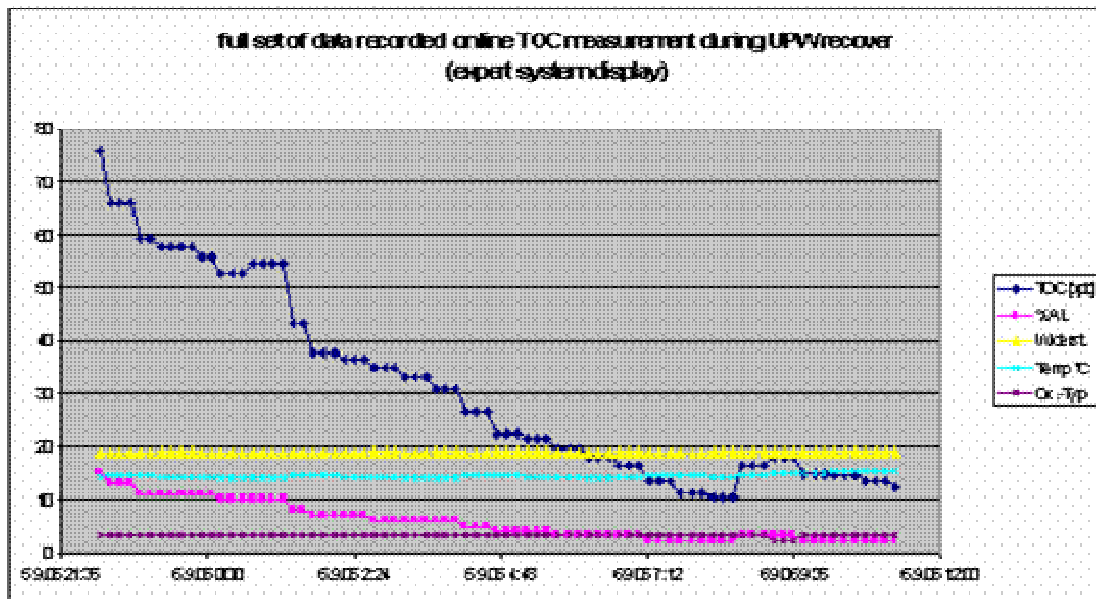

Fig. 6: example of the readout of the expert system of the UPW control system
Blue=TOC [ppb], yellow= resistance [M Ω .cm], light blue Temperature [C].

Improvements on the system since start up

- Continuous and online monitoring of the particle contamination in the UP water loop
- Quality control of the HPR (high pressure rinsing) by a facility control plan (TOC; Bacteria; Particulates)
- Improved HF absorber (Fig. 8)
- Facility management plan for exchange of parts subject to wear and tear. Improved algorithm for cooling of the acid during all runs of 120 to 360 minutes length (Fig. 6)
- Installation and online monitoring of EP acid activity (U/I cell integrated in the EP acid cycle (Fig. 9)
- Improved rotating shaft seals at the rotational feed head
- Isolation of the electrode to improve the removal ratio Iris / Equator
- First crosscheck of EP simulation software by comparison of the software out put with evolutionary optimization results

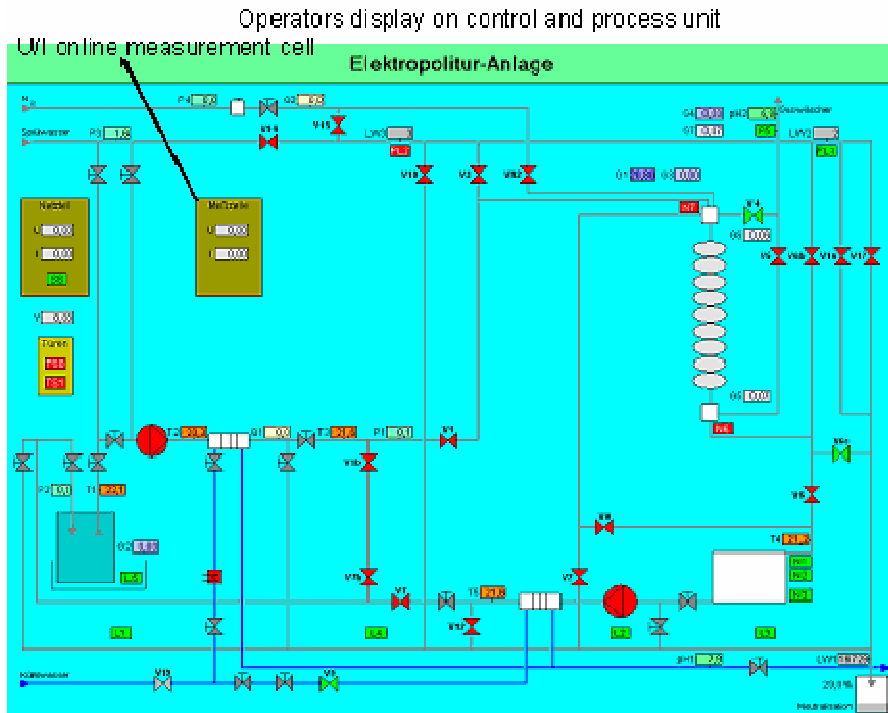

Fig. 7: Online display of the EP operator panel



Control and operation system for the individual HF absorber cartridges

HF Absorber unit of the DESY EP facility with 8 independent cartridges

Fig. 8: Picture of the new development of gas scrubber for HF exhausting gasses

EP U/I test cell integrated into the EP acid line towards the cavity

**Fig. 9:** U/I parameter measurement cell installed into the EP acid line**EP Apparatus parameters for stable operation**

Design parameters of the DESY EP apparatus	
Voltage	17 V
Rotation speed	1 turn/ min
Acid volume	10 l/min
electrode OD	40 mm
Electrode material	Al 99.5
Active Al Surface	9 · 10mm · OD 40 mm
Average temperature	
Cavity inlet	24 °C
Cavity outlet	29 °C
Acid usage up to	12 g solved Niobium per litre acid
HF out gassing Allowed values	< 0,5 ppm HF gas concentration

Table 1: General parameters of the DESY EP system

EP polishing processes		
Main EP		
	Duration	2 · 360 Min
	Removal	126 µm
Fine EP		
	Duration	1 · 120 min
	Removal	42 µm

Table 2: Process parameters of the cavity preparation by Electro polishing

Ultra pure water characteristics		
TOC		
	Standard	2 ppb
	Max	100 ppb for 3h
Particles	Standard	< 20 Counts / litre of 0,3 µm
Resistance	Standard	< 18 MOhm · cm
Temperature	T _{min} 18° C	T _{max} 20 °C

Table 3: Characteristic data of the DESY ultra pure water system